



EXTRUDE
HONE®

SHAPING YOUR FUTURE Truck Applications by Extrude Hone



iStock

MAKING THE WORLD SAFER, HEALTHIER & MORE PRODUCTIVE®



EXTRUDE
HONE®

Truck Applications by Extrude Hone

Designed by us

Extrude Hone has been in business since the 1960's , building on its proprietary technology of extrude honing, which has developed into what it is more commonly know today as Abrasive Flow Machining (AFM). Along the way additional technologies have been added to the portfolio offering, like Thermal Deburring (TEM) and Electrochemical Machining (ECM). These three technologies match various finishing needs in the Truck industry.

We are proudly contributing to make Truck Fuel Systems more efficient.

The first truck components Extrude Hone processed were exhaust manifolds to increase airflow and prevent heat and friction that can warp or even crack the exhaust manifold

Since then, plenty of new applications have developed.

We still do AFM for exhaust manifolds and turbo - housing but the latest development have been around fuel injection and most recently gearboxes.

Most of today's volume applications are for components used in the Fuel Systems like the Fuel Pump, the Common Rail and the Injector Body including the sub-components like the Valve part, the nozzle and the needle.



iStock



Source ZF



iStock



EXTRUDE
HONE®

The Applications in a nutshell

To meet today's commercial fleet component requirements we delivered the best of our technologies.

For medium or heavy-duty diesel with today's strict regulation it's a real challenge to save fuel while you cut carbon dioxide, Nox and particulate emissions.

The OEM's have had to design super high-performance systems and components now working at 2500 bar pressure and even above. The challenge to make components survive these extreme conditions was passed to the manufacturers and the expectation in post processing became tremendous.

Abrasive Flow Machining (AFM) and MICROFLOW, Thermal Deburring (TEM) and Electrochemical Machining (ECM) are key technologies to achieve the most advanced finishing requirements. Now all these technologies are implemented hand in hand with automation.

Transmission needs for commercial vehicles changed as well with the introduction of the latest gearbox generation. ECM is applied on multiple components but also for crankshaft finishing.

It's all about fine deburring, radiusing, stress relief and cleanliness to guarantee the performance designers expect.



iStock



Source Bosch



EXTRUDE
HONE®

Surface matters, Finishing Methods as well.

Extrude Hone finishing methods

Depending your finishing requirements, the component geometry, material and the manufacturing process we have solutions for you.

Surface Finishing

Abrasive Flow Machining is still the way to go when you want to improve flow quality and performance. It's the process suitable by nature for additive intricate passageways requiring surface improvement.

MICROFLOW & MICROFLOW HIGHFLOW are processes dedicated to flow tuning, The high flow variation remove any limitation in terms of nozzle size which is perfect for truck nozzles.

Electrochemical Machining/Deburring (ECM /ECD) is a deburring and edge radiusing technology. Electrochemical machining is a method that finishes the workpiece surfaces by means of anodic metal dissolution.

TEM - When it's all about burrs removal and cleanliness without radiusing the edges, Thermal Energy Method is the Solution as it removes burrs, flashing and unwanted particles in milliseconds.



Source Bosch





EXTRUDE
HONE®

The Pump, a heart beat at 2500 bar & more

Multiple processes for multiple purposes

The pump is the fuel systems heart providing a diesel stream to feed the system. Nowadays, the pumps endure high pressure now up to 2500 bar or 250MPa and even above.

The pump design features multiple intersected holes and various complex intersections between holes and the main bore. Due to the high working pressure, these edges are subject to stress concentration that could potentially generate cracks and pump failure.

The Electrochemical machining operation is performed in one-step delivering both deburring of low-pressure areas, and deburring combined with edge radiusing of the high-pressure areas. All critical edges will benefit from stress relief. Such operation requires no more than 40 seconds time cycle per part.

CHALLENGE

- Remove burrs and create small radius at intersection

BENEFITS

- Eliminate risk of cracks under high working pressure



Source Bosch



EXTRUDE
HONE®

The Common Rail, binding the pump and the injectors.

Not exactly a basic component.

The Common Rail function is to deliver the diesel stream to all injectors. It's fed by the pump and sees high pressure. With 90° cross hole design directing the fuel to the multiple ports, this component features multiples highly stressed areas.

Independently of the number of ports, the Electrochemical machining will deburr and radius the critical intersections while simply deburring less critical ones. The inner radius applied to the 90° intersections are in the range of 0.1mm to 0.4mm.

All areas are processed by introducing a single cathode inside the main bore— assuming design permits. Otherwise additional cathodes provide machining at the same time in other areas.

The illustration, shows the cathode (isolated section in blue, non-isolated section in gold) ready to be inserted in the Common Rail. The non-isolated section will match the inner areas to be processed while the cathode is in position.

Multiple rails could be processed at the same time depending of the equipment, the tooling and the expected productivity.

CHALLENGE

- Remove burrs and create small radius at intersection

BENEFITS

- Eliminate risk of cracks under high working pressure



Source Bosch

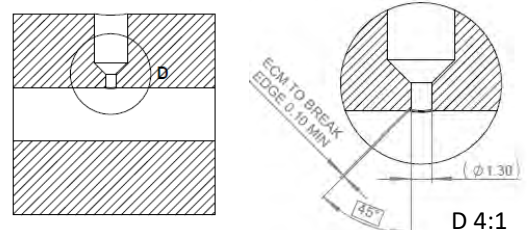
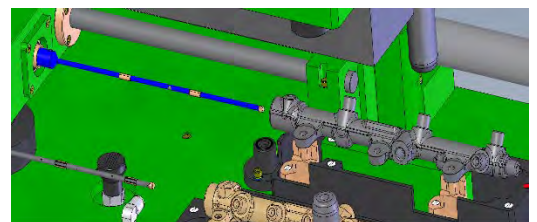



EXTRUDE
HONE®

The Injector body.

Multiple processes for multiple purposes

The Injector Body is a complex component, assuming multiple functions. The Injector body is holding multiple sub-components including the key ones we focus on like the nozzle, the injector valve, the needle.

The Injector Body itself requires some fine finishing to perfectly operate.

There are some critical areas that require fine finishing by Electrochemical Machining to generate a defined radius and other areas that would require only simple deburring.

All will be done at once. Bottom right a photo of the tooling used to process two parts at the same time.

CHALLENGE

- Remove burrs and create small radius at intersection

BENEFITS

- Eliminate risk of cracks under high working pressure



Source Bosch

Before ECM

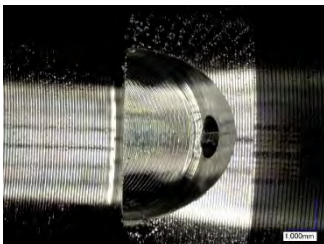

After ECM

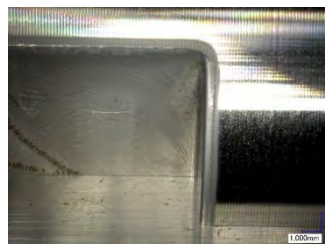
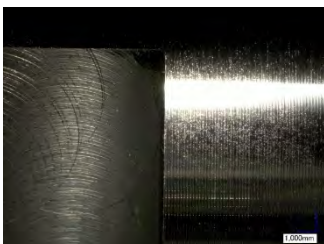
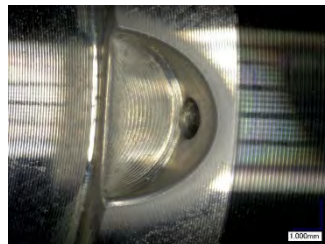



EXTRUDE
HONE®

Injector valve, precise dosing.

Fine finishing for one key precise components.

Injector includes various valves arrangement to inject the fuel in a sequenced manner. The needle movement is controlled by a pressurized reservoir in the pressure balancing plate which is actuated (by a piezo electric valve) in order to release the pressure from the balancing reservoir and enable the needle to move to the open position to inject the right amount of high-pressure fuel through the two-way valve orifice plate to the nozzle and into the combustion chamber.

The injector valve is the one on top of the system. Smooth surfaces and round edges are a must have for a perfect accuracy..

AFM for high volume is the solution to achieve the edge and surface requirement in specific areas - see colored zones in right illustration.



CHALLENGE

- Remove micro-burrs and create small radius at intersection
- Smooth the interior surfaces to get a better-quality flow

BENEFITS

- Eliminate risk of fuel contamination
- Guarantee the achievement of target functionalities

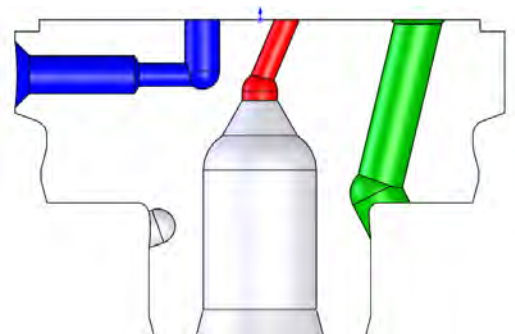
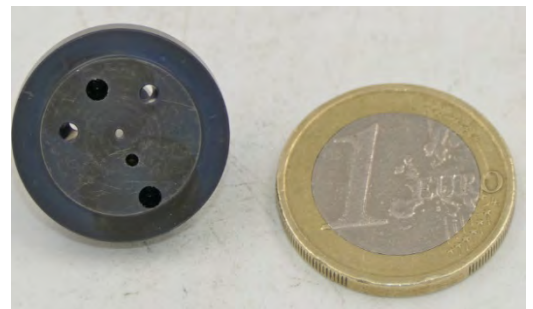



EXTRUDE
HONE®

Fuel nozzle, gas combustion improvement

Get the right K factor to get the right atomization.

What is K factor?

Simply put, a K Factor (regarding fuel nozzles), is the comparison between the inlet diameter to the outlet diameter of a given spray hole.

This K Factor can be defined as:

$$K = \frac{D_{\text{inlet}} - D_{\text{outlet}}}{(10 \times L)}$$

L is the Length of the hole, very often being in the 1mm range

A positive K Factor would mean a conical spray hole, with a larger inlet than outlet (for instance a 2µm inlet, and a 1µm outlet would result in a K Factor of .1). Conversely, a negative K Factor would result in a conical spray hole with a larger outlet than inlet.

By combining optimization of the spray hole (K Factor ratio) and its geometry (rounding of the inlet diameter edge) smaller spray holes can be used, allowing for a greater wall thickness, while keeping the flow coefficient at a constant. By doing so, regulations can be met by a better atomization of the fuel which allows for a cleaner, more efficient, combustion and all-around efficiency, as well as maintaining engine life and performance.

Through the MICROFLOW process, nozzles can be directly flow tuned to their desired flow conditions, while simultaneously rounding the inlet diameter edge and maintaining the K Factor of the spray hole.

CHALLENGE

- Keep the hole geometry
- Radius the inlet holes
- Keep sharp outlet holes

BENEFITS

- Keep the K factor
- Flow tuned to the desired flow conditions
- Perfect rounding of the inlet hole
- Works for OEM and for Aftermarket suppliers.

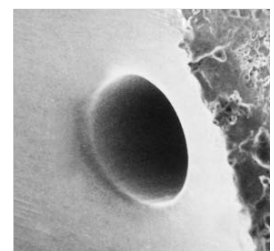
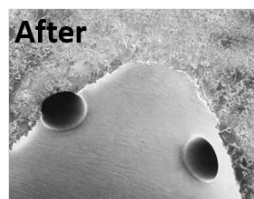
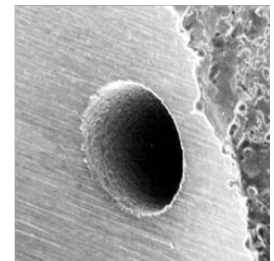
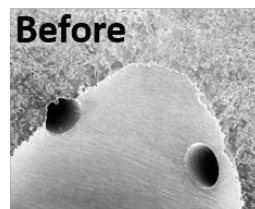

Gears, radius and stress relief

Ensuring a smooth transmission

Latest generation of automatic gearboxes are now out in the market for commercial vehicle. The applications initiated in Automotive are now leveraged as well in these stronger variations.

This industry is looking to enhanced fatigue strength, which means radiusing teeth edges, and to ensure that components are free of microcontaminant.

Mechanical action could fit the first needs but will generate secondary burrs.

Electrochemical Machining (ECM) delivers a better solution. It will shape a perfect edge radius, under tight tolerances, everywhere with the same accuracy and without generating any contaminant as dissolving the material. It does this at high productivity level.

In a planetary design transmission several components are likely to be ECM processed: sun wheel, output shaft, center gear, guide wheel shaft and planet gears.

Above applications are now taking shape for Mild-Hybrid transmissions.

Regarding EV, we even hear about use of more sophisticated gearboxes to get the best efficiency. Of course here, silence matters.

CHALLENGE

- Complex polishing of curved surfaces

BENEFITS

- Automated process with accurate, consistent and repeatable machining
- Fast cycle times - 7.5s / planet gear on a 6-fold fixture for high volume production
- Improve surface finish as well as deburr and radius in a single operation

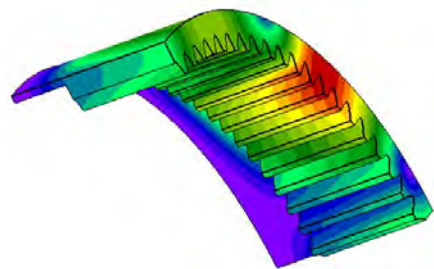

Source ZF



Gears, deburring and cleanliness

Eliminate all burrs and micro burrs to avoid oil contamination

Machining of gear components leaves behind micro-burrs which can break off and contaminate the transmission oil leading to premature maintenance requirements and even failure of the transmission system.

The Thermal Energy Method uses a high temperature heat wave to vaporize micro-burrs and micro-contaminants instantaneously without creating secondary burrs. No mechanical process can achieve the same results.

This method is particularly well-suited to high volume production, offering very fast cycle times and cost per part.

Sometime the TEM is used prior to an ECM operation.

CHALLENGE

- Remove burrs at intersecting holes
- Eliminate micro-contaminants on all internal and external surfaces

BENEFITS

- Automated process with accurate, consistent and repeatable machining



Source ZF



EXTRUDE
HONE®

Clutch Housing

Radiusing solution for snap ring groove and gear front face.

The clutch housing is a vital component across different architectures (including hybrid and full EV) to ensure that the transmission performs at its best.

Insufficient deburring of the snap ring groove and tooth profile on this components increases scrap rate and has a negative impact on assembly time. ECM is a selective, reliable and repeatable machining process that deburrs and radiuses the target area without damaging the sealing area which has very tight tolerances. With Electrochemical Machining, ECM, you can rest assured that every part will be burr free and have the pre-defined radius.

The ECM process is very well suited for high-volume production and can help you improve productivity in your manufacturing process.

CHALLENGE

- Deburr and radius snap ring groove ($R < 0.1\text{mm}$)
- + Deburr and radius tooth profile ($R < 0.3\text{mm}$)
- + No work to be done to the sealing area
- + Reduce component scrap rate

BENEFITS

- Automated process with accurate, consistent and repeatable deburring and radiusing
- Reduced scrap rate and therefore increased cost saving





EXTRUDE
HONE®

Exhaust Manifold, optimising engine breathing

Smoothing exhaust manifolds interior surface helps increasing performance.

By improving the interior surface of the manifold, wall drag is reduced and airflow is increased. With stock and unprocessed manifolds by AFM, surface roughness is left within the manifolds and increases wall drag, reducing airflow, and therefore increases heat and friction. This increased heat and friction can warp or even crack the exhaust manifold and reduce performance as it also restricts airflow.

The AFM process uses pressure to force an abrasive media (a putty like material) throughout the ports and runners of the exhaust manifold. As this media travels through the manifold it removes any surface roughness that may have been left during the casting process. The result being a greatly improved and smooth interior surface.

Illustration showing inner smooth surface (right) and two exhaust manifolds being processed at once (bottom).

CHALLENGE

- Smooth the interior surface
- Polish difficult to reach areas

BENEFITS

- Smoother surface
- Improved laminar air flow
- Reduce the heat
- Minimize risk of field failures due to cracking
- Highest process stability and controllability.



Source PDI



Source PDI Behind the Scene at Extrude Hone



Crankshaft

Solution for radiusing and deburring of hard-to-reach areas on crankshafts where highest process reliability is required.

Truck Crankshaft ECM applications are mostly driven by cost reduction on the preparation of the oil channel system. Of course, creating consistent radius and increasing surface quality of the channels increases fatigue strength and the overall life span of the product.

Electrochemical machining (ECM) for deburring and radiusing of the most critical areas on a crankshaft enables increased durability of the powertrain at low cost per part. By nature ECM is also capable to cope with large components and is easy to integrate in a fully or semi-automatized line.

CHALLENGE

- Finishing of all cross holes on oil intersections on the crankshaft
- Required minimum radius 0.3mm

BENEFITS

- 3 minutes cycle time
- Improve stress resistance and cleanliness
- Minimize risk of field failures
- Highest process stability and controllability.





EXTRUDE
HONE®

ABS Valve Block

Removing the burrs that could compromise safety

The ABS valve is a vital component that makes the braking systems of modern vehicles so effective. The ABS valve prevents the wheels from locking under extreme braking conditions which can drastically reduce stopping distance.

The valve block is full of drilled intersections which are left with burrs. If a burr is left behind, it can detach during the life of the block and cause a seizure in the ABS valve hydraulics. This, in turn, could compromise the braking function and have serious implications to the safety of both the occupants of the vehicle and other road-users or pedestrians.

With Electrochemical Machining, ECM, you can be confident that no burrs are left behind and, what's more, you can improve productivity in your production at the same time.

CHALLENGE

- Ensure complete removal of burrs at all drilling intersections within the valve block
- High volume production necessitates highly productive solution

BENEFITS

- Automated process with accurate, consistent and repeatable machining
- Be 100% confident that all burrs are gone





EXTRUDE
HONE®

Equipment or Contract Shop, your choice

Extrude Hone supports customer in the Truck market in various ways:

Feasibility – Testing

- Test different technologies or a combination to find the perfect solution that suits their needs
- Test structure removal using TEM - different structures require different approaches.

Contract shops

- No need to invest - we have contract shops that can do the job for you.
- **Equipment**
- Want to keep the process a secret, bring machines to your location
- The full equipment portfolio is for sale. We will support you during ramp-up and we will be beside you for service and consumables in the long term.





Industry Experience

BURGMAIER HIGHTECH uses ECM to provide The Edge.

Radiusing & shaping solution for bore intersections at high-pressure areas of injector bodies. Absolute burr-free conditions by using ECM and thus achieves fatigue resistance in high-pressure components along with optimal efficiency due to enhanced flow properties.

The diesel fuel injection system is one of the core components of a diesel engine. It is responsible to supplying the right amount of fuel at exactly the right time.

Nowadays, where increasingly stringent emission standards force the manufacturers to lift the efficiency of their engines. Modern diesel engines, for example, are using pressures over 2000 bar to increase the efficiency of the internal combustion. This also means immense stresses, especially on the bore intersections of the high-pressure area.

Tobias L., responsible for the ECM processes at BURGMAIER Hightech GmbH in Laupheim, gives us an insight to his daily work and how collaboration with Extrude Hone helps them to provide the edge: “I have joined BURGMAIER in 2004 as foreman for lines in the production. After several years of experiencing the ECM processes in our production I`m now responsible for maintenance of all the ECM equipment in our plant. Since we started using ECM at our facility in Laupheim we have always relied on the expertise and experience from Extrude Hone. This very close partnership starts with running feasibilities during the bidding phase in early project phases, finding and defining the perfect production process steps for ensuring best parts quality and cleanliness, and perfecting aftermarket service support with innovative ideas to optimize our processes and to lower our running costs.

We are an international manufacturer of precision parts. We have succeeded in both consolidating our position as a technology market leader and fulfilling the needs of our global customer base. Customer satisfaction is our top priority – we achieve it with the three pillars of our corporate culture: expertise, precision and reliability. With continuous improvement and by working closely with our customers, we aim to achieve technology and cost leadership.”



iStock



EXTRUDE
HONE®

Industry Experience

Extrude Hone has been a ZF supplier of choice for ECM systems since 2006. Multiple components of an automatic gearbox benefit from the Electrochemical process.

In a planetary design transmission several components are likely to be ECM processed: sun wheel, output shaft, center gear, guide wheel shaft and planet gears.

In addition Thermal Deburring is used for simple deburring operation, to reduced burrs volume prior to ECM, or simply to eliminate all potential contaminants.

Quality of the gearing helps to reduce wear, vibration, friction and noise while reducing oil contamination. Superior automatic gearbox quality comes with perfect controlled edge breaks which ECM can performed with short time cycle contributing to high level productivity while fully integrated in production line.

May, 2020:

“Last year ZF and Extrude Hone agreed on several projects in order to streamline our product costs. Nowadays ZF is able to implement this technical cost savings in their shop floor, particularly regarding new transmission projects.

Many thanks to Extrude for their readiness and support!”

C. Hauser, Manager Corporate Material Management - ZF
Commodity machine and equipment related tools



Source ZF





EXTRUDE
HONE®

Industry Experience

Delphi-TVS is a joint venture between Delphi Automotive systems (USA) and T.V. Sundaram Iyengar & Sons (Kancheepuram, India). Delphi one of the largest automotive suppliers in the world and Delphi-TVS is the largest automotive systems supplier in India.



“Being a global company, we have a great responsibility to maintain world-class quality standards in our products,” says T.N. Umasankar, head of the Delphi-TVS manufacturing engineering department. “We manufacture diesel fuel injection parts – high-volume components. The main issue is burr removal on cross-sectional holes from previous machining operations.”



iStock

Although it’s not spoken openly – and many wouldn't even admit to it – deburring is fast becoming a quality issue that won’t go away.

Companies, using state of the art precision machinery, can produce complex components these days that many design engineers couldn’t even dream of a few years ago. Part now take seconds to produce but minutes to deburr. Bottle-neck in production are now in the deburring sections and costs are biased toward finishing rather than production. Whilst the expectation of machine precision quality and repeatability has increased, huge damage and irregularities can still be done by hand deburring.

The TEM process is particularly appropriate for high-volume applications where conventional deburring departments struggle to keep pace,” Umasankar agrees. “ Its instantaneously deburr a large number of intersecting holes, threads and hard-to-reach areas in a flash, literally in 20 milliseconds. Its ability to fire multiple components at the same time increases its capacity and cost-effectiveness enormously. Any other process, including high-pressure water jet, will not provide this value.”

After experiencing quality improvement and substantial reduction in rejection we opted to go for two more TEM machines from Extrude Hone to cope with our production. We would say it is a nice experience to collaborate with Extrude Hone for value addition to our end products.”



Industry Experience

Ventura use ECM for automotive braking system components.

Headquartered in Les Franqueses del Vallès in Spain and with facilities in Houston, USA and Suzhou, China, Ventura Precision Components is an expert in the supply of high-precision turned components for the automotive sector and for other market segments such as trucks, motorbikes and aeronautics.

With more than 45 years' experience, Ventura supplies components to leading Tier 1s such as Robert Bosch, Continental and TRW and prides itself in its ability to offer the highest quality components at competitive prices. Ventura's primary product line is pistons for brake system, and, in this market, they are worldwide leaders in the production of new generation pistons.

Ventura's success lies in no small part in its use of state-of-the-art equipment and production processes. One of these processes is electrochemical machining (ECM) and Extrude Hone is proud to support Ventura in delivering superior quality components to the end customers.

Electrochemical machining works on the principle of anodic metal dissolution and provides a high degree of precision on components that are difficult to manufacture and finish using conventional methods. Because ECM is a non-contact process, it does not subject the workpiece to mechanical or thermal stresses. This means no burrs/secondary burrs and no distortion of the workpiece, even on thin-walled aluminum components. ECM is very well suited for Ventura's high-volume production and offers great accuracy and a high degree of repeatability.

Ventura use ECM to deburr and radius cross-hole intersections on piston plungers (depicted in the image). It is critical that this area is free of burrs. A burr detaching from these cross holes could contaminate the brake's hydraulic system causing the system to seize or damage seals allowing hydraulic oil to leak and/or air to enter the system rendering the system ineffective.



Source Ventura



Source Ventura



EXTRUDE
HONE®

Industry Experience

Recently Extrude Hone had the pleasure of hosting Performance Diesel Inc. (PDI) at our Irwin facility, located just outside of Pittsburgh, PA.

As an industry leader in diesel aftermarket components, PDI uses Extrude Hone's Abrasive Flow Machining (AFM) process to enhance the precision and maximize the performance and longevity of their exhaust manifolds; even under the most extreme of conditions.

The AFM process uses pressure to force an abrasive media (a putty like material) throughout the ports and runners of the exhaust manifold. As this media travels through the manifold it removes any surface roughness that may have been left during the casting process. The result being a greatly improved and smooth interior surface.

By improving the interior surface of the manifold, wall drag is reduced and airflow is increased. With stock and unprocessed manifolds by AFM, surface roughness is left within the manifolds and increases wall drag, reducing airflow, and therefore increases heat and friction. This increased heat and friction can warp or even crack the exhaust manifold and reduce performance as it also restricts airflow.

Since wall drag is reduced on PDI's Exhaust Manifold, via the AFM process, airflow increases, removing residual heat and increasing life by helping to prevent any warping – while also increasing the performance of your engine. Not only this, but PDI's partnership with Extrude Hone enables PDI to offer an industry leading 3 Year Manufacturer's Warranty on their manifolds.



PERFORMANCE DIESEL INC.



Source PDI

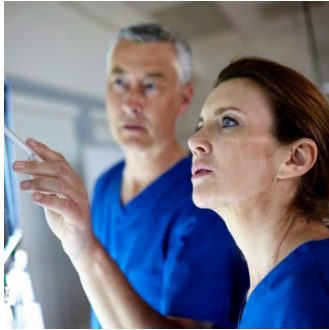

EXTRUDE HONE®
SHAPING YOUR FUTURE

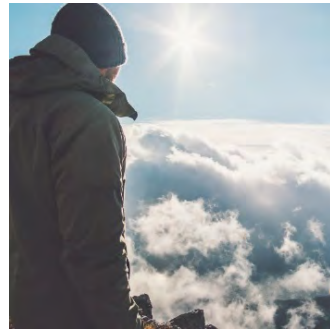
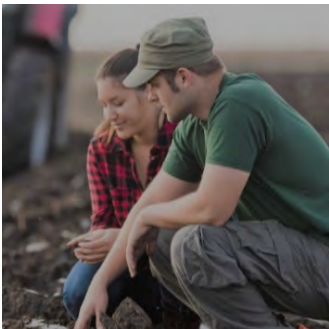

MADISON®
INDUSTRIES